

NM - NMD



Pompe centrifuge monobloc taraudée 2900 tours/minute



NM



NMD

NM - NMD Pompe centrifuge monobloc taraudée 2900 tours/minute

Données techniques

Exécution

Electropompes centrifuges monobloc avec accouplement direct moteur-pompe et arbre unique.

NM : à un étage.

NMD : à deux roues opposées (avec équilibrage de poussée axiale).

Orifices : taraudés ISO 228/1.

Utilisations

Pour liquides propres sans particules abrasives, non agressifs pour les matériaux de la pompe (avec parties solides jusqu'à 0,2% max.).

Pour l'alimentation en eau.

Pour les installations de chauffage, conditionnement, refroidissement.

Pour applications civiles et industrielles.

Pour service incendie.

Pour irrigation.

Limites d'utilisation

Température du liquide de - 10 °C à + 90 °C.

Température ambiante jusqu'à + 40 °C.

Hauteur d'aspiration maxi : 7 mètres.

Pression finale maximum admissible dans le corps de pompe : 10 bars

(16 bars pour pompes NMD 25-190; NMD 32-210; NMD 40-180).

Service continu.

Construction

Composant	Matériaux
Corps de pompe Lanterne de racc.	Fonte GJL-200 EN 1561
Roue	Laiton P- Cu Zn 40 Pb 2 UNI 5705
NM 17	Fonte GJL-200 EN 1561
Arbre	Acier au Cr AISI 430 Acier au Cr Ni AISI 303 de 1.10 à 2.20 kW
Garniture mécanique	Carbone dur / Céramique / NBR

Moteur

Moteur à induction à 2 pôles, 50 Hz ($n = 2900 \text{ trs/min}$).

NM, NMD : triphasé 230/400 V \pm 10% jusqu'à 3 kW;
400/690 V \pm 10% de 4 à 9,2 kW;

NMM, NMDM : monophasé 230 V \pm 10%,
avec protection thermique.

Isolation classe F.

Protection IP 54.

Moteur triphasé haut rendement IE3 à partir de 0.75 kW.

Exécution selon EN 60034-1; EN 60034-30-1;

EN 60335-1; EN 60335-2-41.

Exécutions spéciales sur demande

- Autres voltages.
- Fréquence 60 Hz.
- Protection IP 55.
- Garniture mécanique spéciale.
- Pour liquide ou ambiance avec températures plus élevées ou plus basses.

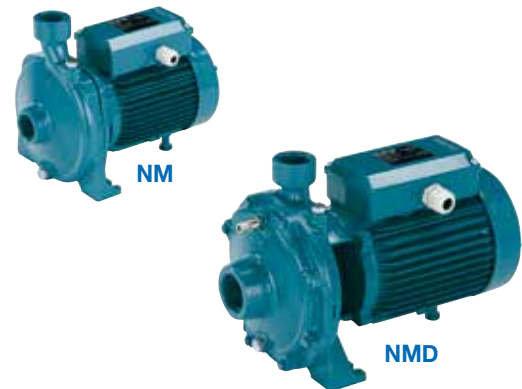

Plage d'utilisation

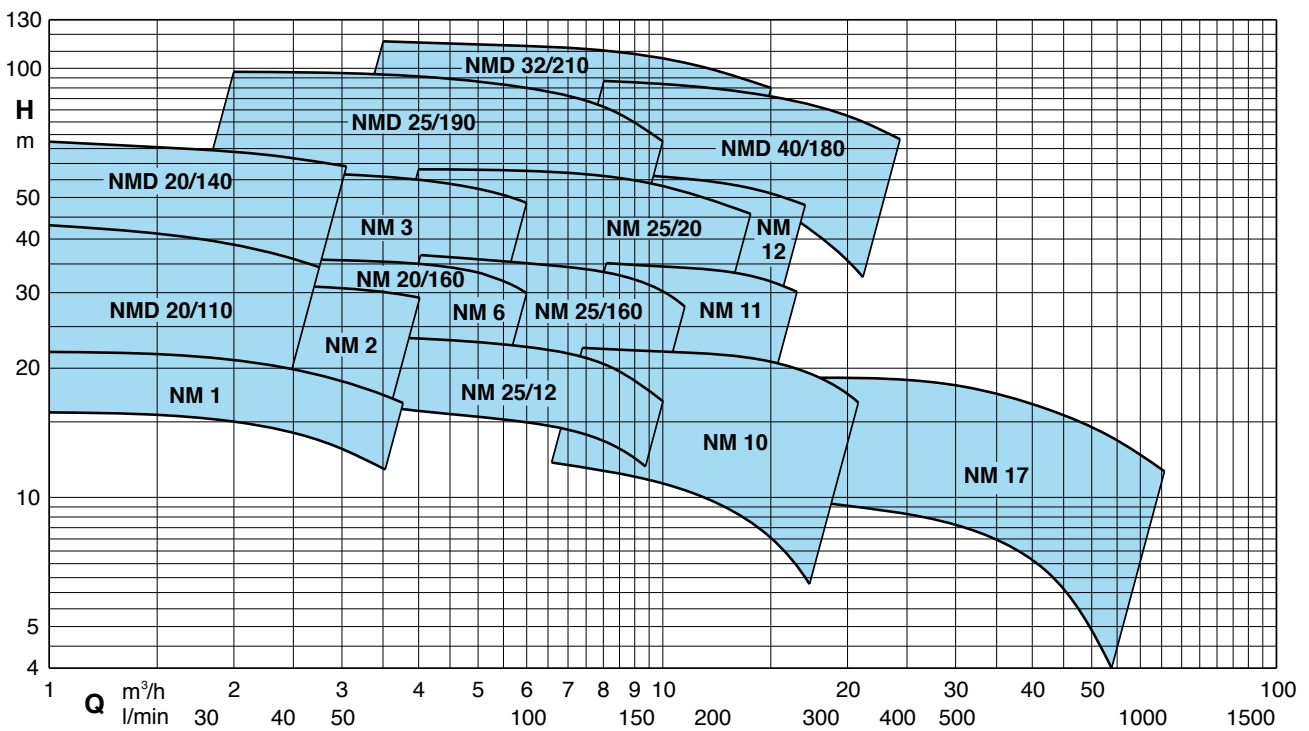

NM - NMD Pompe centrifuge monobloc taraudée 2900 tours/minute

Performances n ≈ 2900 trs/min

Aspiration taraudée femelle Ø1" (26/34) - Refoulement taraudé femelle Ø1" (26/34)

Référence	MOTEUR		Kg	m³/h l/min	1	1.2	1.5	1.89	2.4	3	3.6	4.2	4.8	5.4	6	6.6	7.5	8.4
	kW	A			16	20	25	31.5	40	50	60	70	80	90	100	110	125	140
NM 1A	0.37	1.3	8.6	H m	22	21.6	21.3	20.9	20.3	19.4	18.1	16.3	-	-	-	-	-	-
NMM 1A		3	8.7															
NM 2B	0.55	1.7	13.1															
NMM 2B		4.5	14															
NM 2S	0.55	1.7	13.3															
NMM 2S		4.5	14.2															
NM 2A	0.75	2.2	14.2															
NMM 2A		6	15.1															
NM 6B	0.75	2.2	17.6															
NMM 6B		6	17.8															
NM 6A	1.10	2.7	19															
NMM 6A		7.4	19.3															
NM 3C	1.10	2.7	22.9															
NMM 3C		7.4	24															
NM 3B	1.50	4.3	25.1															
NMM 3B		9.2	26															
NM 3A	2.20	5.3	29.1															
NMM 3A	1.80	11.2	30.4															

Aspiration taraudée femelle Ø1"1/4 (33/42) - Refoulement taraudé femelle Ø1" (26/34) *sauf NM20-160 Ø3/4 (20/27)

Référence	MOTEUR		Kg	m³/h l/min	1	1.2	1.5	1.89	2.4	3	3.6	4.2	4.8	5.4	6	6.6
	kW	A			16	20	25	31.5	40	50	60	70	80	90	100	110
NMD 20-110B	0.45	1.3	12.1	H m	33	32	31	29	26.5	23	18	-	-	-	-	-
NMDM 20-110B		3.6	13													
NMD 20-110Z	0.55	1.7	13													
NMDM 20-110Z		4.5	14													
NMD 20-110A	0.75	2.2	14.2													
NMDM 20-110A		5.6	15.1													
NMD 20-140B	1.10	2.7	22.7													
NMDM 20-140B		7.4	23.9													
NMD 20-140A	1.50	4.3	24.8													
NMDM 20-140A		9.2	25.2													
NM 20-160B*	0.75	2.2	18.4													
NMM 20-160B*		5.6	19.9													
NM 20-160A*	1.10	2.7	19.7													
NMM 20-160A*		7.4	20.7													

M = Monophasé

Aspiration taraudée femelle Ø1"1/2 (40/49) - Refoulement taraudé femelle Ø1" (26/34)

Référence	MOTEUR		Kg	m³/h l/min	2.4	3	3.6	4.8	6	6.6	7.5	8.4	9.6	10.8	12	13.2	15	16.8	18
	kW	A			40	50	60	80	100	110	125	140	160	180	200	220	250	280	300
NM 25-12B	0.55	1.6	12.3	H m	20	19.9	19.8	19.3	18.5	18	17.3	16.3	15	13.2	11	-	-	-	-
NMM 25-12B		4.2	13.2																
NM 25-12A	0.75	2	13.3																
NMM 25-12A		5.4	14.2																
NM 25-160B	1.10	2.7	19.7																
NMM 25-160B		7.4	20.4																
NM 25-160A	1.50	4.3	21.5																
NMM 25-160A		9.2	22.5																
NM 25-20B	2.20	5.3	31.6																
NM 25-20A	3.00	6.6	40.9																
NM 25-20S	4.00	9.6	42.2																
NMD 25-190C	2.20	5.3	42																
NMD 25-190B	3.00	6.6	49.7																
NMD 25-190A	4.00	9.6	51.5																

NM - NMD Pompe centrifuge monobloc taraudée 2900 tours/minute

Performances n ≈ 2900 trs/min

Aspiration taraudée femelle Ø2" (50/60) - Refoulement taraudé femelle Ø1"1/4 (33/42)

Référence	MOTEUR		Kg	m³/h l/min	6.6	7.5	8.4	9.6	10.8	12	13.2	15	16.8	18.9	21	24
	kW	A			110	125	140	160	180	200	220	250	280	315	350	400
NM 10F	0.55	2.3	18.5	H m	12.5	12.5	12	11.5	11	10	9	7.5	-	-	-	-
NMM 10F		4.2	19.3													
NM 10D	0.75	2.3	18.8													
NMM 10D		5.8	19.4													
NM 10A	1.10	2.7	19.3													
NMM 10A		7.4	20.2													
NM 10S	1.50	4.3	21.5													
NMM 10S		9.2	22.1													
NM 11B	1.50	4.3	24.1													
NMM 11B		9.2	24.7													
NM 11A	2.20	5.3	28.1													
NM 12D	2.20	5.3	33.5													
NM 12C	3.00	6.6	42													
NM 12A	4.00	9.6	43.5													

Aspiration taraudée femelle Ø2" (50/60) - Refoulement taraudé femelle Ø1"1/4 (33/42) *sauf NMD 40-180 Ø1"1/2 (40/49)

Référence	MOTEUR		Kg	m³/h l/min	5.4	6	6.6	7.5	8.4	9.6	10.8	12	13.2	15	16.8	18.9	21	24
	kW	A			90	100	110	125	140	160	180	200	220	250	280	315	350	400
NMD 32-210D	4.00	9.6	60.5	H m	71	69	67.5	65	62.5	58	53	46	37	-	-	-	-	-
NMD 32-210C	5.50	10.9	71															
NMD 32-210B	7.50	14.3	77															
NMD 32-210A	9.20	18.5	99															
NMD 40-180D*	4.00	9.6	59.5															
NMD 40-180C*	5.50	10.9	70															
NMD 40-180B*	7.50	14.3	76															
NMD 40-180A*	9.20	18.5	97															

Aspiration taraudée femelle Ø2"1/2 (66/76) - Refoulement taraudé femelle Ø2"1/2 (66/76)

Référence	MOTEUR		Kg	m³/h l/min	21	24	27	30	33	37.8	42	48	54	60	66
	kW	A			350	400	450	500	550	630	700	800	900	1000	1100
NM 17H	1.10	2.7	22.2	H m	9.5	9.2	9	8.6	8.2	7.5	6.7	5.5	3.5	-	-
NMM 17H		7.4	23												
NM 17G	1.50	4.3	23.2												
NMM 17G		9.2	24.2												
NM 17F	2.20	5.3	28.2												
NM 17D	3.00	6.6	36.2												

M = Monophasé

Aspiration manométrique maximum : 1 à 2 mètres

Courbes hydrauliques $n \approx 2900$ trs/min

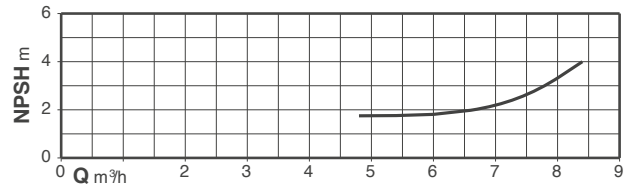
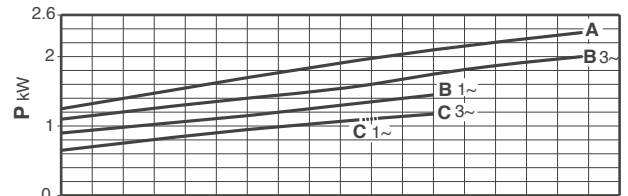
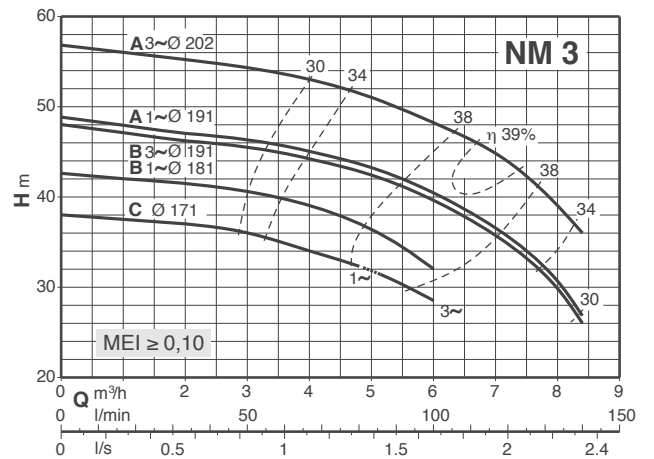
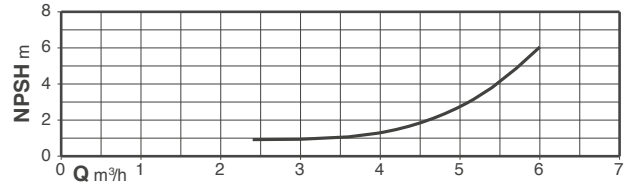
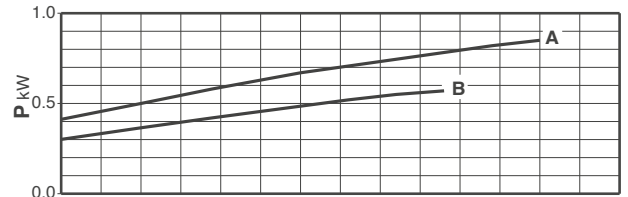
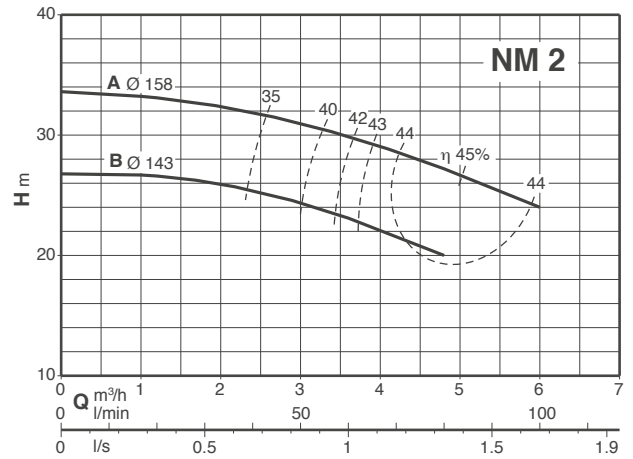
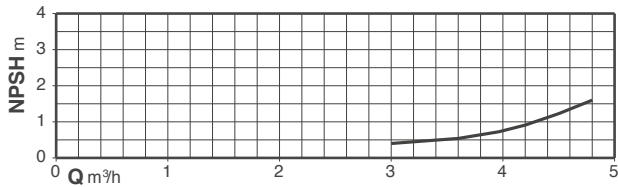
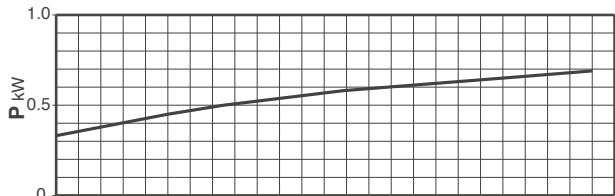
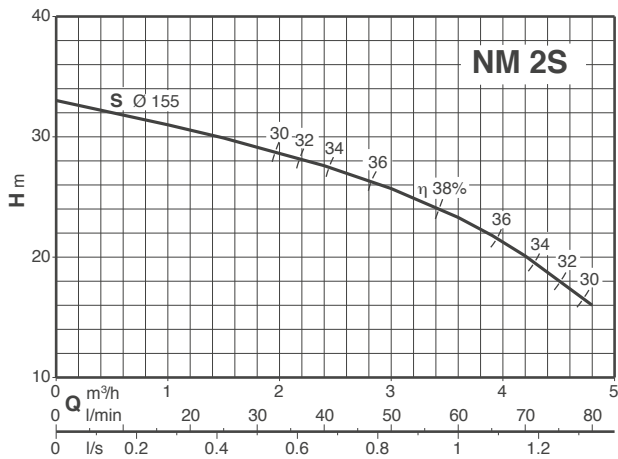
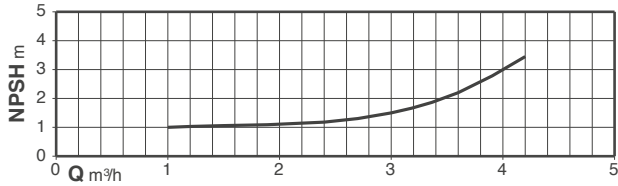
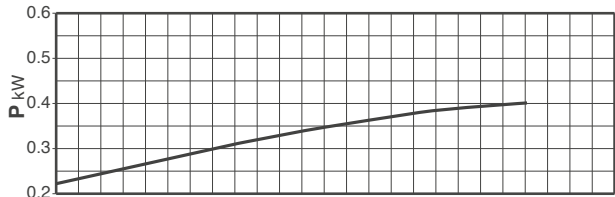
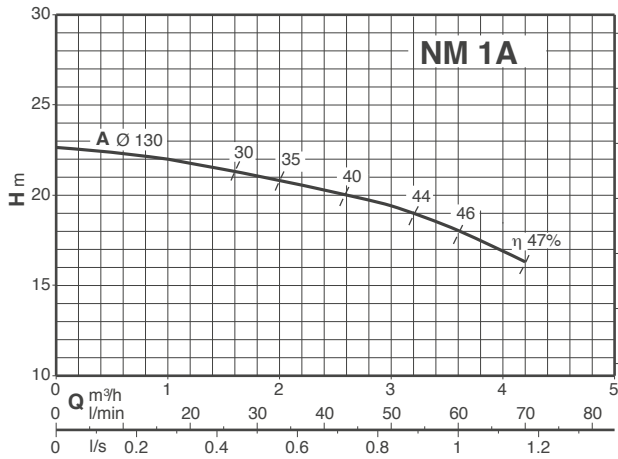

Courbes hydrauliques $n \approx 2900$ trs/min

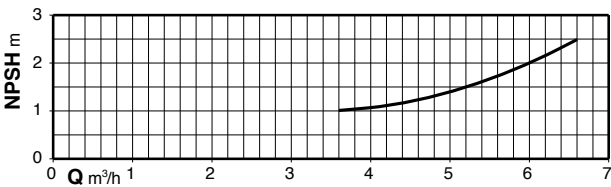
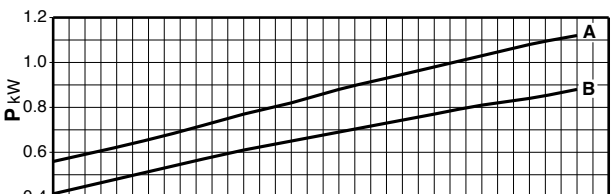
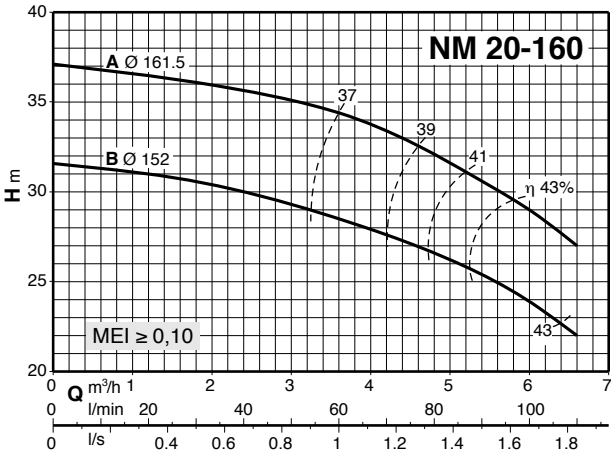
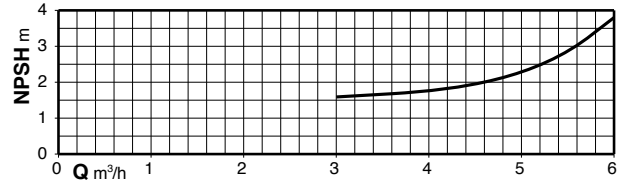
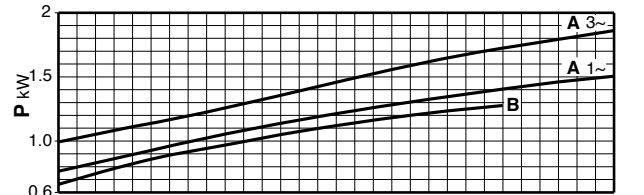
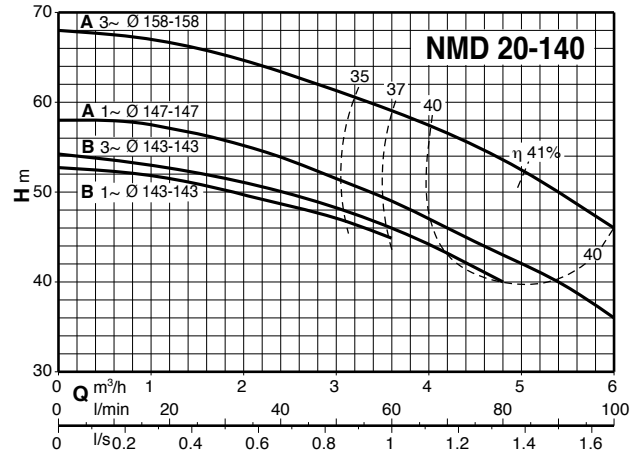
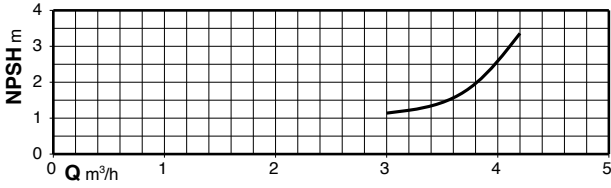
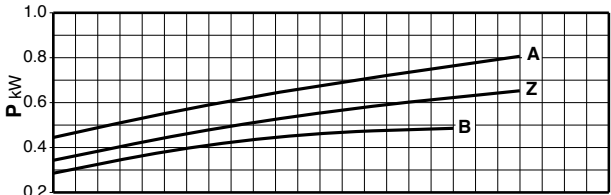
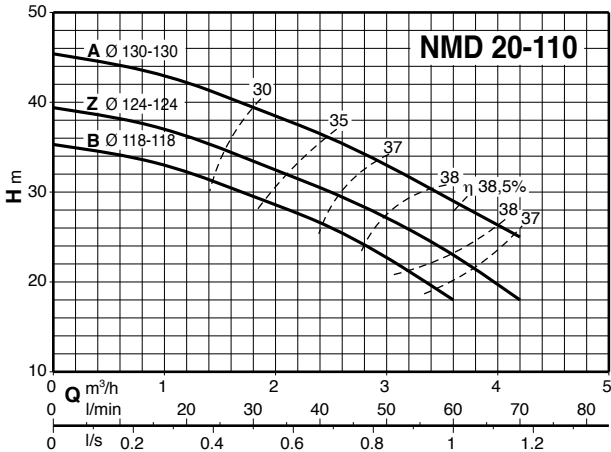

Courbes hydrauliques $n \approx 2900$ trs/min

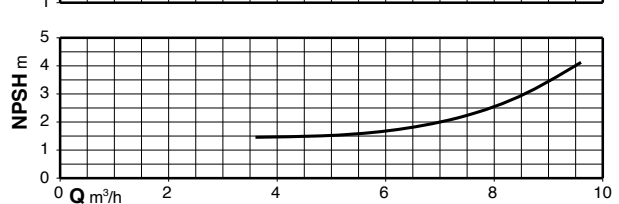
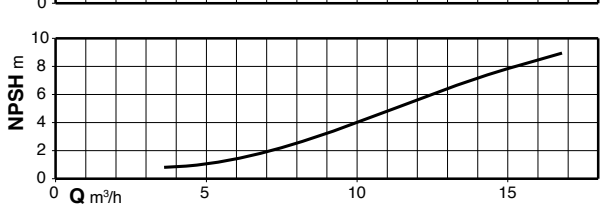
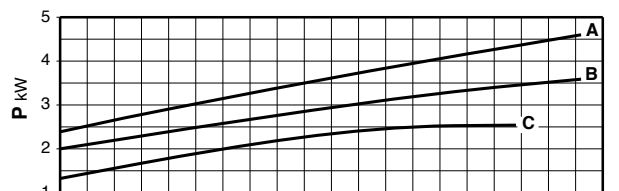
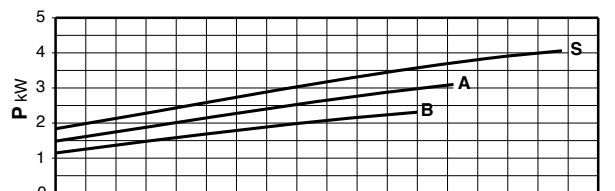
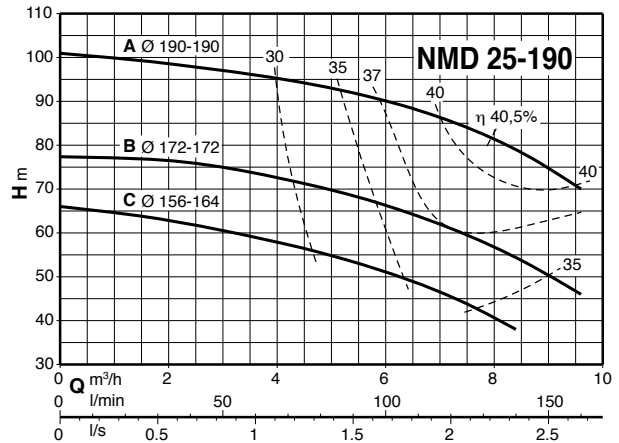
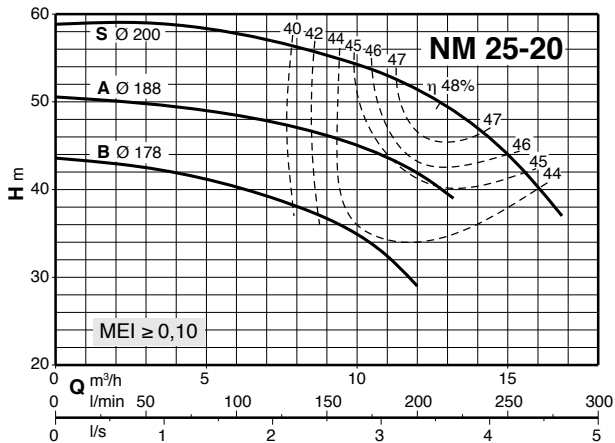
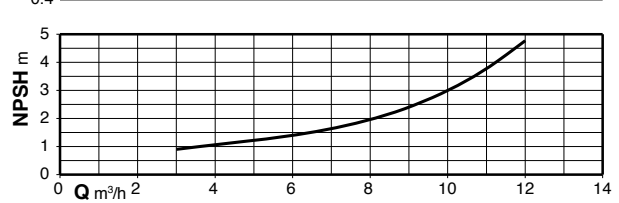
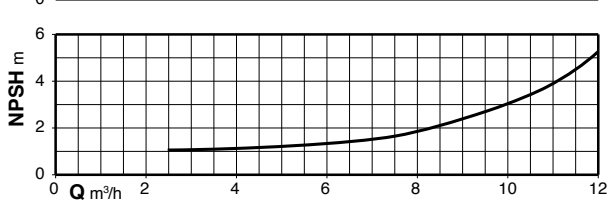
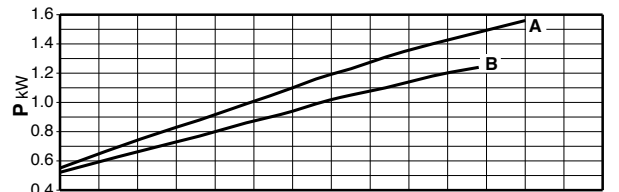
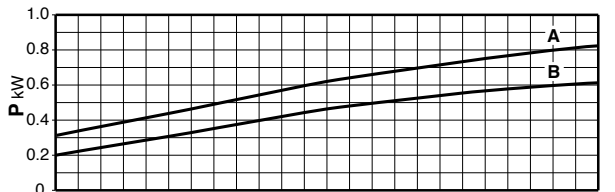
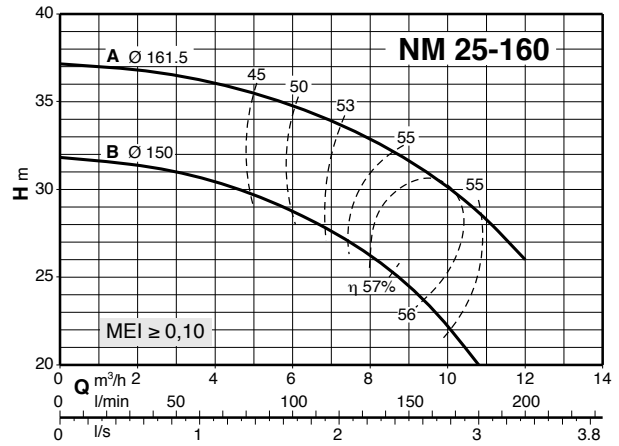
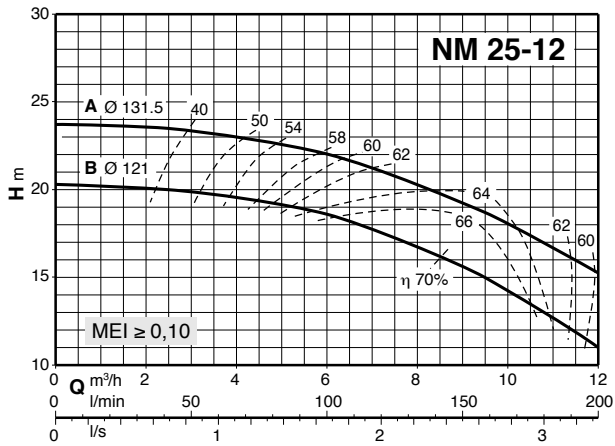

Courbes hydrauliques $n \approx 2900$ trs/min

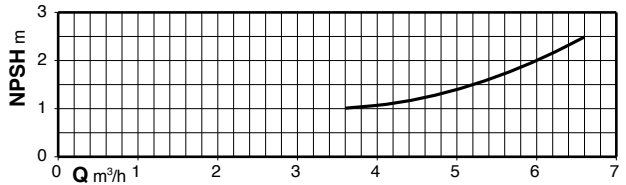
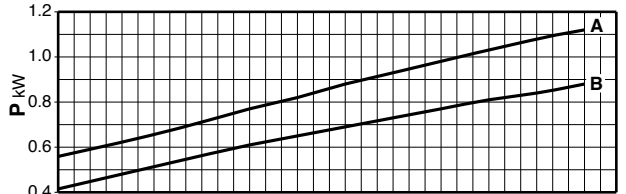
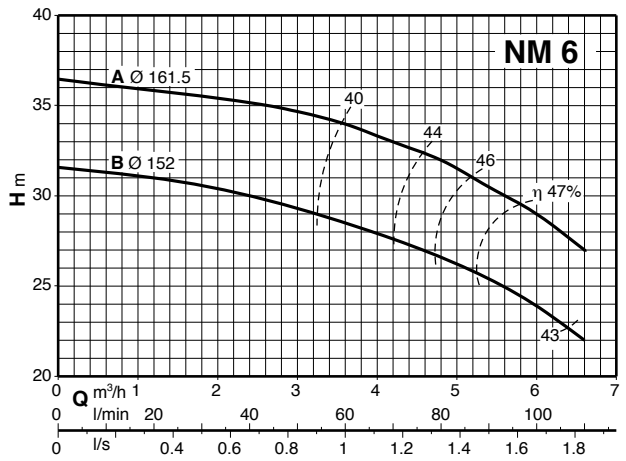
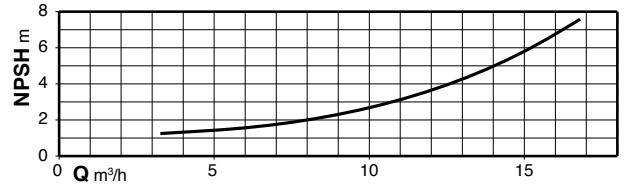
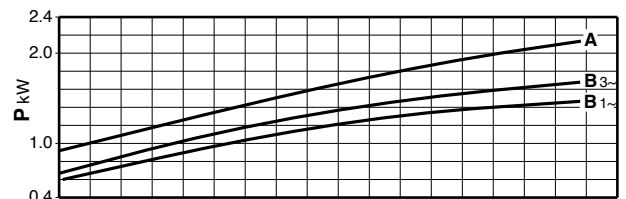
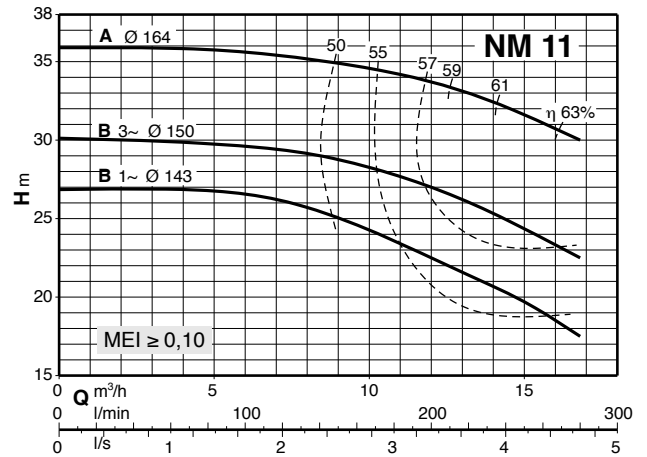
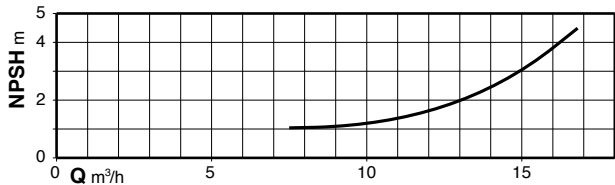
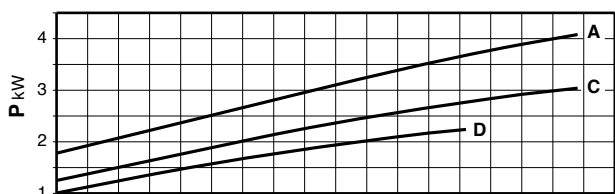
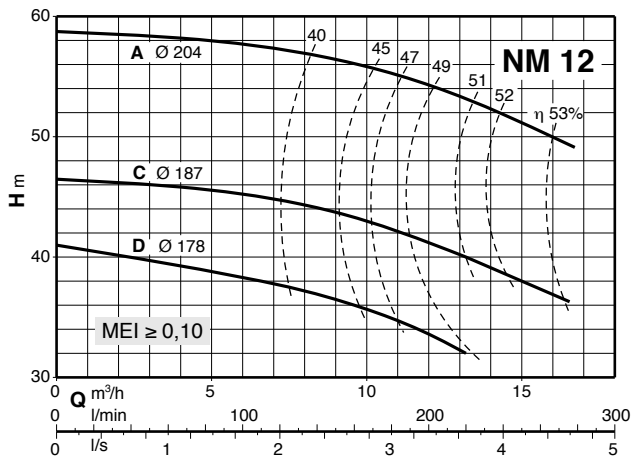
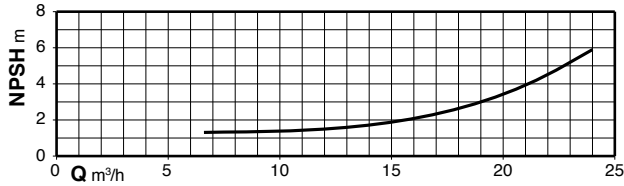
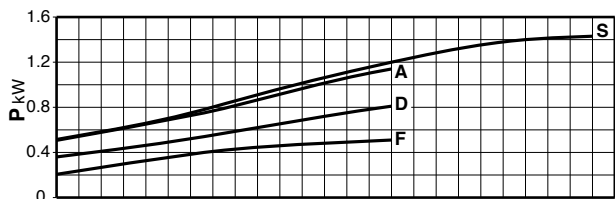
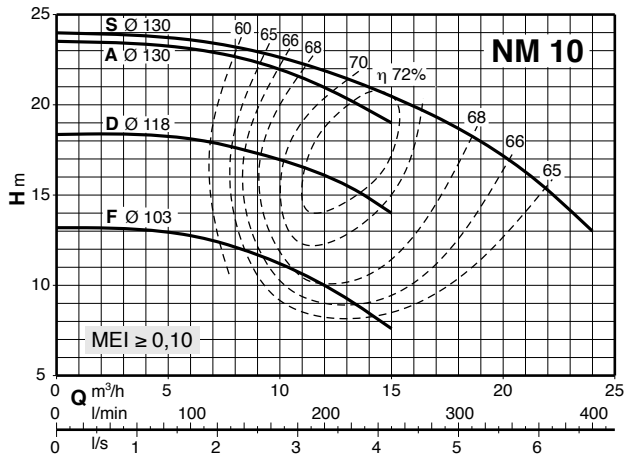

Courbes hydrauliques n ≈ 2900 trs/min

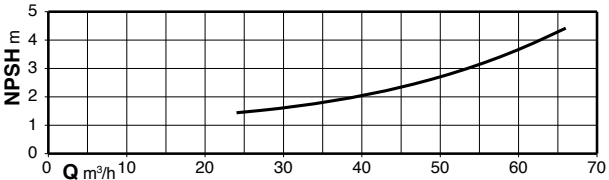
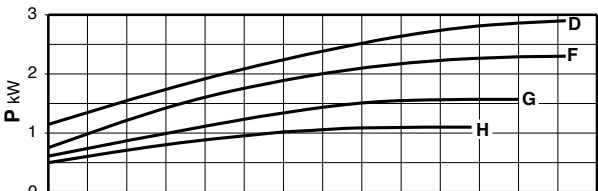
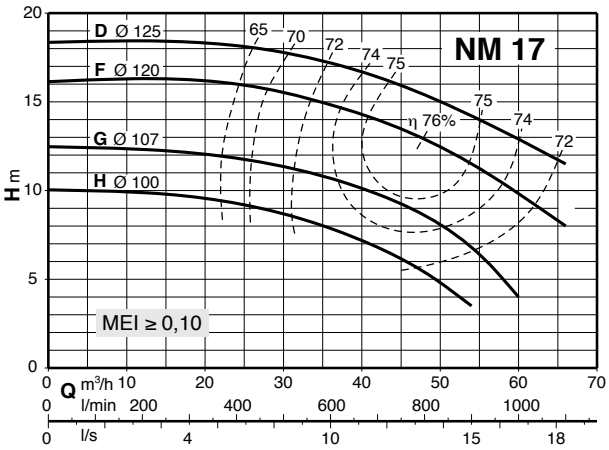
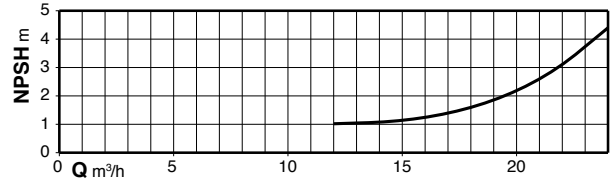
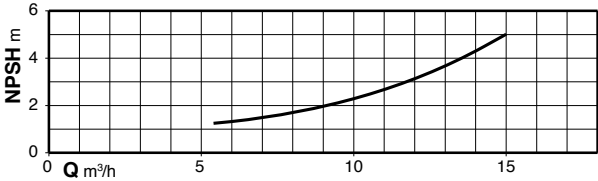
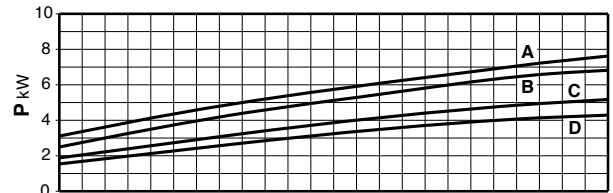
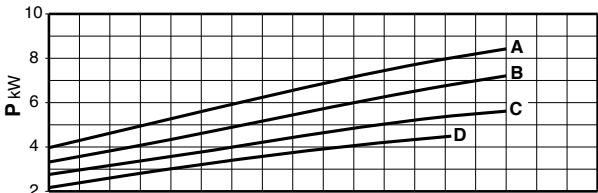
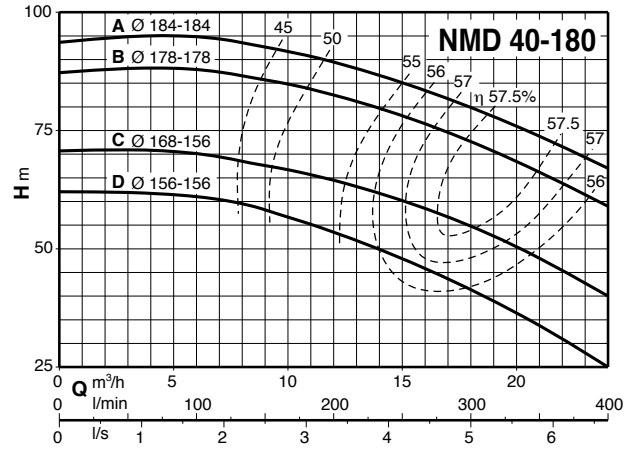
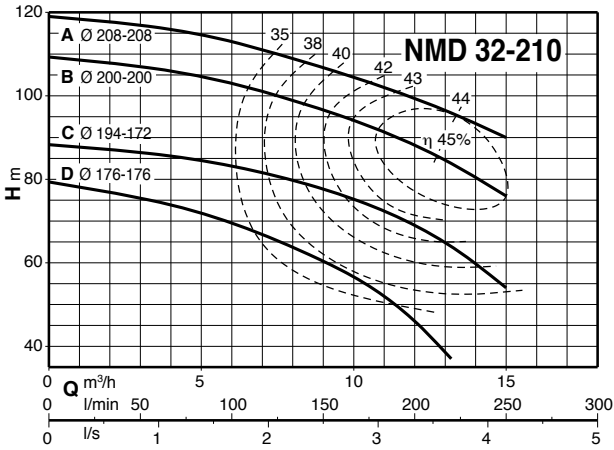

DESSIN COMPACT

La structure compacte permet l'installation dans des espaces réduits.

CONSTRUCTION ROBUSTE

La structure mécanique des parties en contact avec le liquide pompé est conçue de manière à garantir une résistance accrue aux sollicitations mécaniques.

DESSIN EXCLUSIF

Pour la sécurité des utilisateurs un nouveau dispositif de protection empêche le contact avec les parties tournantes de la pompe et permet un accès aisé à la garniture mécanique.

FIABILITÉ

Les dimensions des roulements et de l'arbre ont été étudiées pour garantir la réduction des sollicitations mécaniques ainsi qu'une grande fiabilité dans toutes les conditions d'utilisation.

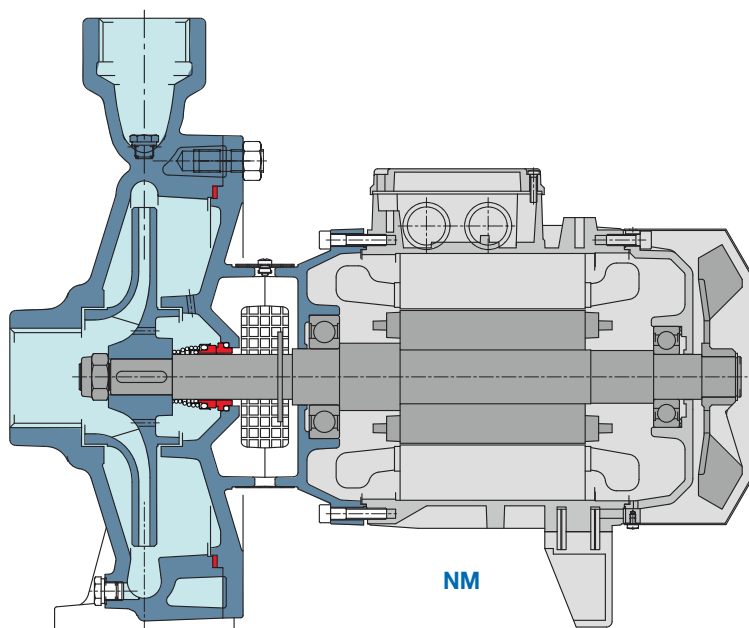

FLEXIBILITÉ D'UTILISATION

Pour les parties en contact avec le liquide pompé il est possible de choisir la fonte ou le bronze ce qui permet l'utilisation des pompes NMD pour le pompage de liquides très variés.

CONSTRUCTION ROBUSTE

La structure mécanique des parties en contact avec le liquide pompé est conçue de manière à garantir une résistance accrue aux sollicitations mécaniques.

FIABILITÉ

Les dimensions des roulements et de l'arbre ont été étudiées pour garantir la réduction des sollicitations mécaniques ainsi qu'une grande fiabilité dans toutes les conditions d'utilisation.

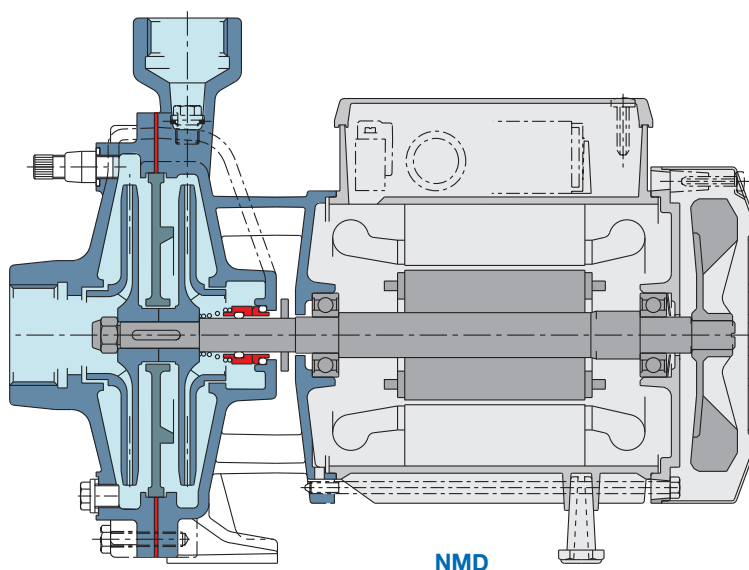

Dimensions et poids

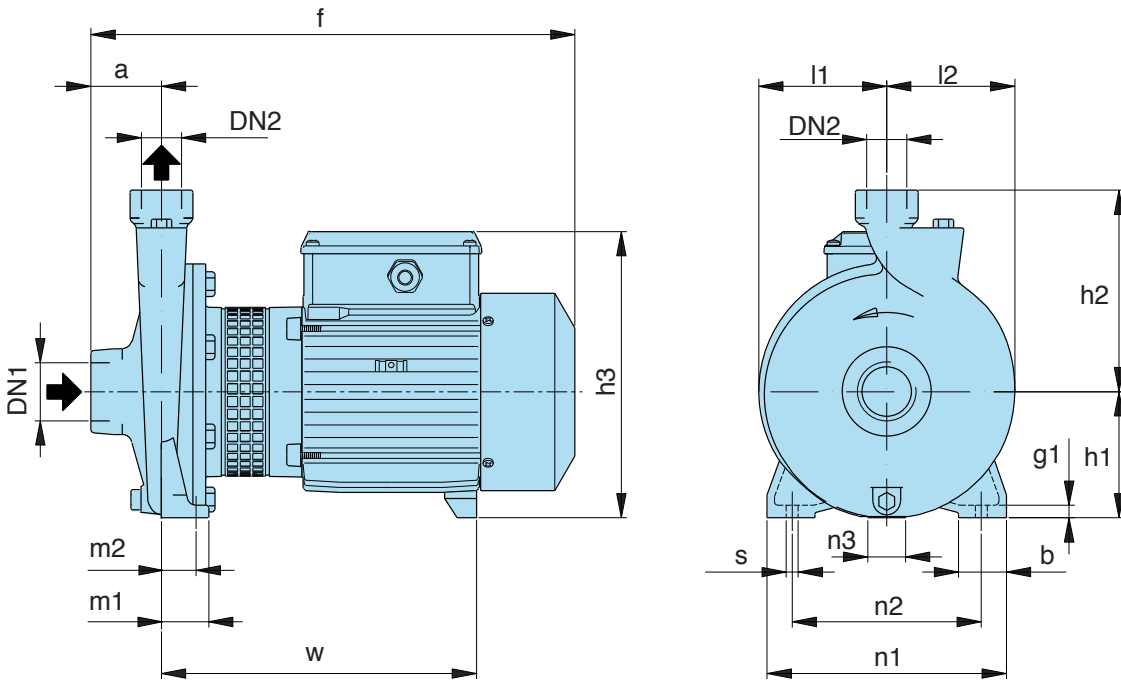

Référence	Poids kg
NM 1A	8.6
NMM 1A	8.7
NM 2B	13.1
NMM 2B	14
NM 2S	13.3
NMM 2S	14.2
NM 2A	14.2
NMM 2A	15.1
NM 3C	22.9
NMM 3C	24
NM 3B	25.1
NMM 3B	26
NM 3A	29.1
NMM 3A	30.4
NM 20-160B	18.4
NMM 20-160B	19.9
NM 20-160A	19.7
NMM 20-160A	20.7
NM 25-12B	12.3
NMM 25-12B	13.2
NM 25-12A	13.3
NMM 25-12A	14.2
NM 25-160B	19.7
NMM 25-160B	20.4
NM 25-160A	21.5
NMM 25-160A	22.5
NM 25-20B	31.6
NM 25-20A	40.9
NM 25-20S	42.2
NM 10F	18.5
NMM 10F	19.3
NM 10D	18.8
NMM 10D	19.4
NM 10A	19.3
NMM 10A	20.2
NM 10S	21.5
NMM 10S	22.1
NM 11B	24.1
NMM 11B	24.7
NM 11A	28.1
NM 12D	33.5
NM 12C	42
NM 12A	43.5
NM 17H	22.2
NMM 17H	23
NM 17G	23.2
NMM 17G	24.2
NM 17F	28.2
NM 17D	36.2

Référence	DN1	DN2	mm																			
	ISO 228		a	f	h1	h2	h3	m1	m2	n1	n2	n3	b	s	l1	l2	w	g1				
NM 1A	G1"	G1"	40	261	80	132	176	40	32	170	140	17	35	9.5	77	81	171	10				
NM 2B	G1"	G1"	45	305	95	150	207	40	32	190	160	17	35	9.5	87	90	203	10				
NM 2S																						
NM 2A																						
NM 3C	G1"	G1"	50	375	112	180	240	55	43	245	205	37	45	11.5	110	113	244	12				
NM 3B				415													284					
NM 3A																						
NM 6B	G1"1/4	G1"	53	369	100	150	213	37.5	27.5	190	150	17	38	9.5	102	102	225	10				
NM 6A																						
NM 20-160B	G1"1/4	G3/4"	53	375	100	150	228	37.5	27.5	190	150	30	38	9.5	102	102	246	10				
NM 20-160A																						
NM 25-12B	G1"1/2	G1"	56	313	90	140	199	37.5	27.5	170	130	9	38	9.5	85	88	195	10				
NM 25-12A																						
NM 25-160B																						
NM 25-160A	G1"1/2	G1"	56	380	100	160	228	37.5	27.5	190	150	30	38	9.5	102	102	246	10				
NM 25-20B																			433	253	49	291
NM 25-20A																			G1"1/2	G1"	63	460
NM 25-20S																						
NM 10F	G2"	G1"1/4	63	382	100	150	228	50	35	190	140	30	50	13	90	97	239	14				
NM 10D																						
NM 10A																						
NM 10S																						
NM 11B	G2"	G1"1/4	70	400	112	170	240	50	35	210	160	37	50	15	103	110	247	14				
NM 11A				440													287					
NM 12D				G2"													G1"1/4		70	440	132	190
NM 12C	470	270	300																			
NM 12A																						
NM 17H	G2"1/2	G2"1/2	80	417	112	160	240	50	35	210	160	37	50	14	96	113	257	14				
NM 17G				463			240					304										
NM 17F				480			250					295										
NM 17D																						

NM - NMD Pompe centrifuge monobloc taraudée 2900 tours/minute

Dimensions et poids

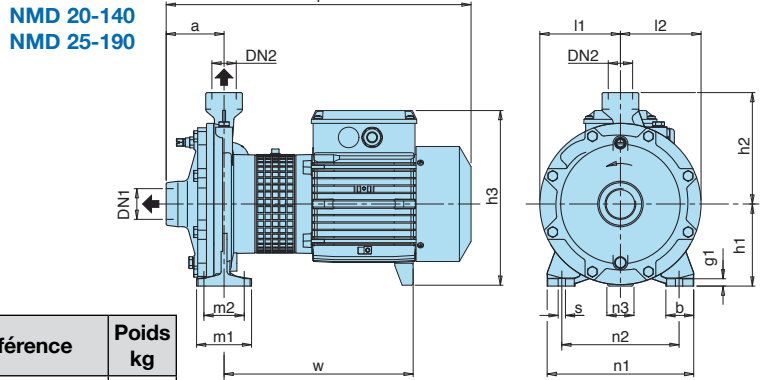
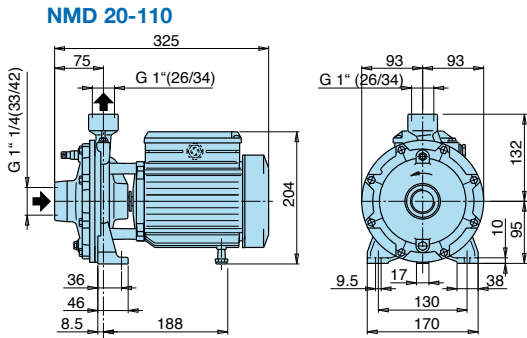

Référence	Poids kg
NMD 20-140B	22.7
NMDM 20-140B	23.9
NMD 20-140A	24.8
NMDM 20-140A	25.2
NMD 25-190C	42
NMD 25-190B	49.7
NMD 25-190A	51.5

Référence	Poids kg
NMD 20-110B	12.1
NMDM 20-110B	13
NMD 20-110Z	13
NMDM 20-110Z	14
NMD 20-110A	14.2
NMDM 20-110A	15.1

Référence	DN1	DN2	mm																
	ISO 228		a	f	h1	h2	h3	m1	m2	n1	n2	n3	b	s	l1	l2	w	g1	
NMD 20-140B	G1"1/4	G1"	80	417	112	152	243	75	55	200	160	37	38	9.5	110	110	256	10	
NMD 20-140A																			
NMD 25-190C	G1"1/2	G1"	97	487	140	180	268	100	70	240	190	50	50	14	133	133	314	13	
NMD 25-190B				500			278					49					306		
NMD 25-190A																			

NMD 32-210
NMD 40-180

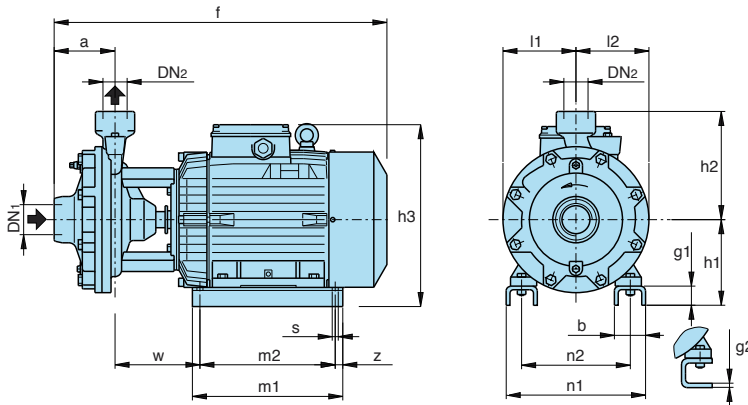

Référence	Poids kg
NMD 32-210D	60.5
NMD 32-210C	71
NMD 32-210B	77
NMD 32-210A	99
NMD 40-180D	59.5
NMD 40-180C	70
NMD 40-180B	76
NMD 40-180A	97

Référence	DN1	DN2	mm																
	ISO 228		a	f	h1	h2	h3	m1	m2	n1	n2	z	b	s	l1	l2	w	g1	g2
NMD 32-210D	G2"	G1"1/4	110	530	155	215	293	205	175	194	140	15	54	10	150	150	139	-	6
NMD 32-210C				550	150		310	280	250	258	190		68	12			108	38	-
NMD 32-210B				625	170		355	298	268	286	216		70	12			152	38	-
NMD 32-210A				625	170		355	298	268	286	216		70	12			152	38	-
NMD 40-180D	G2"	G1"1/2	121	535	155	215	293	205	175	194	140	15	54	10	145	145	133	-	6
NMD 40-180C				555	150		310	280	250	258	190		68	12			102	38	-
NMD 40-180B				630	170		355	298	268	286	216		70	12			145	-	38
NMD 40-180A				630	170		355	298	268	286	216		70	12			145	-	38



Calpeda Pompes

19, rue de la communauté - ZA La Forêt - 44140 LE BIGNON

Tél. 02 40 03 13 30 - Fax 02 40 03 16 70 - email : info@calpeda.fr - www.calpeda.fr

SAS au capital de 1 030 000 € - RCS Nantes B 322 698 093 - Siret 322 698 093 00059 - Code NAF 4669B - N° TVA intra communautaire : FR50322698 093



water passion

NM - NMD - CALPEDA (Doc). Document non contractuel et non définitif. Calpeda France se donne le droit à toute rectification concernant la présente documentation.